

Antero 800NA

FDM Thermoplastic Filament

The information presented are typical values intended for reference and comparison purposes only. They should not be used for design specifications or quality control purposes.

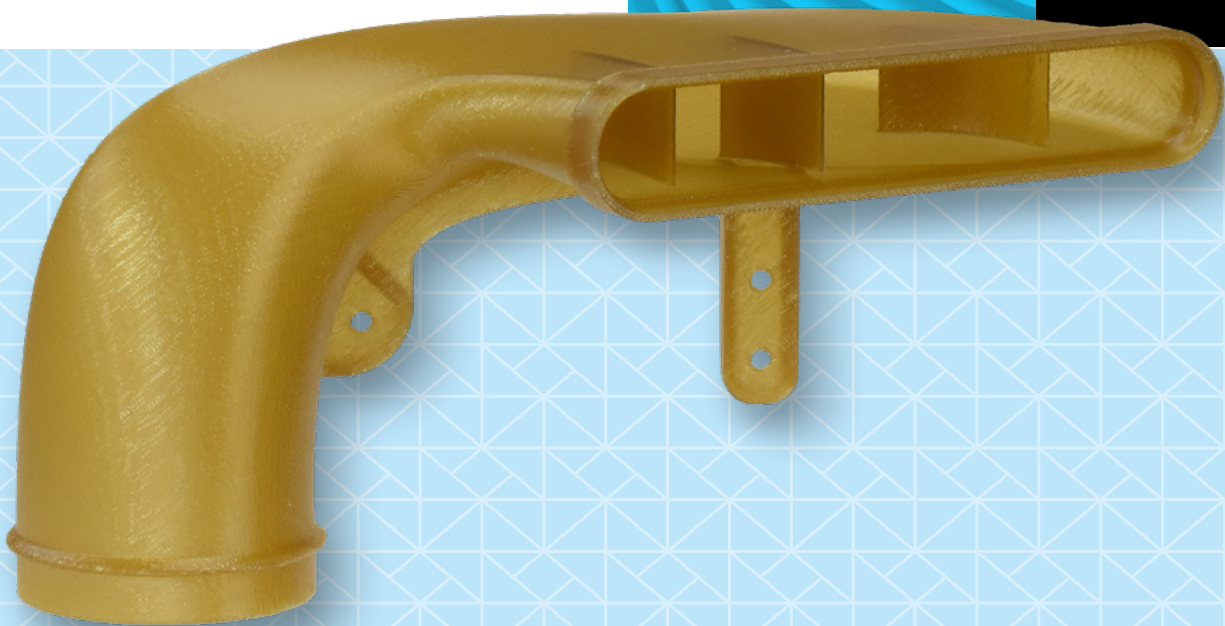



Overview

Antero® 800NA is a PEKK-based FDM® thermoplastic with excellent mechanical properties that include high strength, high heat resistance, toughness and wear-resistance. These superior qualities make it a lighter alternative to aluminum and steel in certain use cases.

Chemical resistance and minimal outgassing provide suitability for aerospace applications where prototypes and parts are exposed to jet fuel, oil, and hydraulic fluid. Other uses include industrial applications where high strength and chemical resistance are needed.

3D printing with Antero 800NA FDM filament avoids the waste associated with subtractive manufacturing of high-cost bulk PEKK material.

Contents:

Ordering Information	3
Physical Properties	4
Mechanical Properties	5
UV Aging and Performance at Temperature	8
Chemical Resistance	9
Flame, Smoke and Toxicity	10
Outgassing	11
Fire Protection of Railway Vehicles	11
Appendix	12





Product Information

Table 1: Printer and Support Material Compatibility

Printer	Model Tip	Layer Height	Support Material	Support Tip
Fortus 450mc™	T20D	0.254 mm (0.010 in.)	SUP8000B™ (breakaway)	T16
Fortus 450mc	T20F	0.254 mm (0.010 in.)	SUP8000B (breakaway)	T16
F900®	T20D	0.254 mm (0.010 in.)	SUP8000B (breakaway)	T16
F900	T20F	0.254 mm (0.010 in.)	SUP8000B (breakaway)	T16

Build Sheet

High Temperature

- 0.51 x 660 x 965 mm (0.02 x 26 x 38 in.)
- 0.51 x 406 x 470 mm (0.02 x 16 x 18.5 in.)

System Requirements

Fortus 450mc

- Hardened machine upgrade
- Hardened Fortus 450mc head
- Antero 800NA material license (included if new system)

F900

- Hardened F900 head
- Antero 800NA material license

Table 2: Antero 800NA Ordering Information

Part Number	Description
Filament Canisters	
355-02500	Antero 800NA, 92.3 cu. in. – Plus
355-03260	SUP8000B, 92.3 cu. in. – Plus
Printer Consumables	
511-10730-S	T20D tip
511-10740-S	T20F tip
511-10401	T16 tip
325-00275-S	High Temperature build sheet, 0.02 x 26 x 38 in. (0.51 x 660 x 965 mm)
325-00475-S	High Temperature build sheet, 0.02 x 16 x 18.5 in. (0.51 x 406 x 470 mm)
Print Heads	
821726-XXXX	Hardened Fortus 450mc head (blue handle)
325-63500	Hardened F900 head (folded sheet metal handle)



Physical Properties

Values are measured as printed. XY, XZ, and ZX orientations were tested. For full details refer to the [Stratasys Materials Test Procedure](#). DSC and TMA curves can be found in the Appendix.

Table 3: Antero 800NA Physical Properties

Property	Test Method	Typical Values	
		XY	XZ/ZX
HDT @ 66 psi	ASTM D648 Method B	158 °C (316 °F)	158 °C (316 °F)
HDT @ 264 psi	ASTM D648 Method B	157 °C (315 °F)	156 °C (313 °F)
Molded HDT @ 66 psi	ASTM D648 Method B		151 °C (304 °F)
Molded HDT @ 264 psi	ASTM D648 Method B		147 °C (297 °F)
Tg	ASTM D7426 Inflection Point		156 °C (313 °F)
Melt Point	ASTM D7426 Peak Heat		300 °C (572 °F)
Mean CTE	ASTM E831 (40 °C to 140 °C)	36.11 $\mu\text{m}/[\text{m}^{\circ}\text{C}]$ (20.06 $\mu\text{in}/[\text{in}^{\circ}\text{F}]$)	50.20 $\mu\text{m}/[\text{m}^{\circ}\text{C}]$ (27.89 $\mu\text{in}/[\text{in}^{\circ}\text{F}]$)
Volume Resistivity	ASTM D257		$> 1.4 \times 10^{14} \Omega \cdot \text{cm}$
Dielectric Constant	ASTM D150 1 kHz test condition		3.32
Dissipation Factor	ASTM D150 1 kHz test condition		0.003
Thermal Conductivity	ASTM E1952 @0 °C		0.2988 W/m*K 0.1727 BTU/(hr*ft°F)
Thermal Conductivity	ASTM E1952 @30 °C		0.3011 W/m*K 0.1740 BTU/(hr*ft°F)
Thermal Conductivity	ASTM E1952 @60 °C		0.3054 W/m*K 0.1765 BTU/(hr*ft°F)
Thermal Conductivity	ASTM E1952 @90 °C		0.3088 W/m*K 0.1785 BTU/(hr*ft°F)
Thermal Diffusivity	ASTM E1952 @0 °C		0.193 mm ² /s 2.99*10 ⁻⁴ in ² /s
Thermal Diffusivity	ASTM E1952 @30 °C		0.174 mm ² /s 2.70*10 ⁻⁴ in ² /s
Thermal Diffusivity	ASTM E1952 @60 °C		0.162 mm ² /s 2.51*10 ⁻⁴ in ² /s
Thermal Diffusivity	ASTM E1952 @90 °C		0.152 mm ² /s 2.36*10 ⁻⁴ in ² /s
Specific Gravity	ASTM D792 @23 °C		1.28



Mechanical Properties

Samples were printed with 0.254 mm (0.010 in.) layer heights on the Fortus 450mc and F900 with T20F tip. For the full test procedure please see [Stratasys Materials Test Procedure](#).

Print Orientation

Parts created using FDM are anisotropic as a result of the printing process. Below is a reference of the different orientations used to characterize the material.

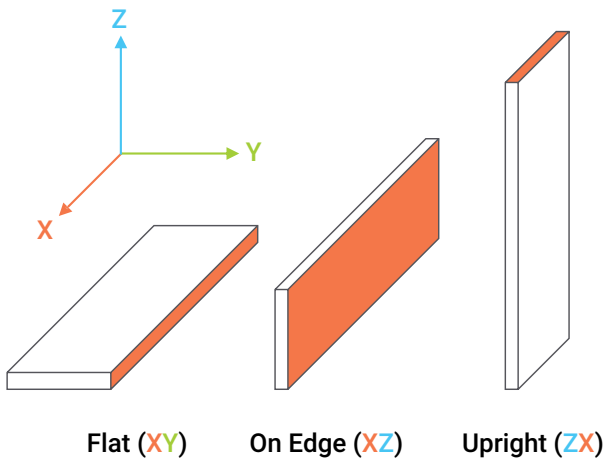

Tensile Curves

Due to the anisotropic nature of FDM, tensile curves look different depending on orientation. Below is a guide of the two types of curves seen when printing tensile samples and what reported values mean.

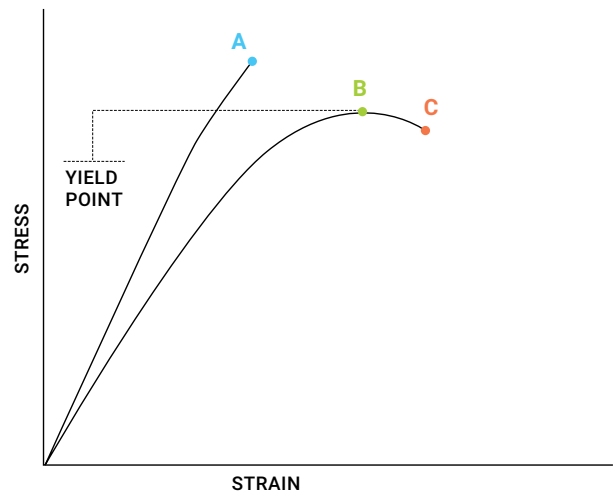

A = Tensile at break, elongation at break (no yield point)

B = Tensile at yield, elongation at yield

C = Tensile at break, elongation at break



Table 4: Antero 800NA Mechanical Properties - F900 - T20F Tip

0.254 mm (0.010 in.) Layer Height		XZ Orientation ¹	ZX Orientation ¹
Tensile Properties: ASTM D638			
Yield Strength	MPa	86.7 (5.0)	59.4 (5.8)
	psi	12300 (720)	8610 (850)
Elongation @ Yield	%	4.7	2.3
Strength @ Break	MPa	73.0 (4.7)	59.7 (5.5)
	psi	10600 (680)	8650 (800)
Elongation @ Break	%	6.1	2.3
Modulus (Elastic)	GPa	2.64 (0.05)	2.77 (0.04)
	ksi	383 (6500)	402 (5.8)
Flexural Properties: ASTM D790, Procedure A			
Strength @ Break	MPa	No break	106 (13)
	psi	No break	15400 (1900)
Strength @ 5% Strain	MPa	136 (2.3)	-
	psi	19800 (340)	-
Strain @ Break	%	No break	4.1
Modulus	GPa	3.20 (0.04)	2.65 (0.03)
	ksi	463 (6.4)	385 (40)
Compression Properties: ASTM D695			
Yield Strength	MPa	95.8 (5.9)	95.4 (4.0)
	psi	13900 (0.85)	13800 (0.58)
Modulus	GPa	2.26 (0.25)	2.30 (0.18)
	ksi	327 (36)	333 (25)
Impact Properties: ASTM D256, ASTM D4812			
Notched	J/m	41.1 (6.9)	33.3 (4.2)
	ft*lb/in.	0.770 (0.13)	0.623 (0.08)
Unnotched	J/m	1730 (680)	203 (35)
	ft*lb/in.	32.5 (13)	3.80 (0.65)

¹Values in parentheses are standard deviations.

Table 5: Antero 800NA Mechanical Properties - Fortus 450mc - T20F Tip

0.254 mm (0.010 in.) Layer Height		XZ Orientation ¹	ZX Orientation ¹
Tensile Properties: ASTM D638			
Yield Strength	MPa	90.0 (5.2)	50.1 (3.6)
	psi	13000 (760)	7270 (530)
Elongation @ Yield	%	4.8	1.8
Strength @ Break	MPa	73.0 (13)	49.4 (3.8)
	psi	10600 (1900)	7170 (550)
Elongation @ Break	%	6.4	1.8
Modulus (Elastic)	GPa	2.71 (0.05)	2.89 (0.05)
	ksi	393 (7.4)	419 (7.8)
Flexural Properties: ASTM D790, Procedure A			
Strength @ Break	MPa	No break	96.6 (11)
	psi	No break	14000 (1700)
Strength @ 5% Strain	MPa	137 (1.85)	-
	psi	19900 (260)	-
Strain @ Break	%	No break	3.6
Modulus	GPa	3.20 (0.02)	3.84 (0.07)
	ksi	464 (5.8)	411 (11)
Compression Properties: ASTM D695			
Yield Strength	MPa	98.4 (4.8)	102 (1.4)
	psi	14300 (700)	14800 (210)
Modulus	GPa	2.46 (0.03)	2.34 (0.15)
	ksi	357 (4.5)	340 (21)
Impact Properties: ASTM D256, ASTM D4812			
Notched	J/m	40.0 (6.3)	30.1 (6.0)
	ft*lb/in.	0.749 (0.12)	0.564 (0.11)
Unnotched	J/m	2730 (1400)	119 (44)
	ft*lb/in.	51.2 (26)	2.23 (0.82)

¹Values in parentheses are standard deviations.



UV Aging

Antero 800NA coupons were built on the F900 using the T20F tip with 0.254 mm (0.010 in.) layer height. Antero 800NA was tested before and after UV exposure. Ten ASTM D638 upright (ZX) coupons were tested in tensile after UV exposure and an additional 10 ASTM D638 ZX coupons were the control (no UV Exposure). The UV exposed samples were cycled in the QUV chamber per ASTM G154 (Standard Practice for Operating Fluorescent Ultraviolet (UV) Lamp Apparatus for Exposure of Non-Metallic Materials) for 1000 hours, alternating for 8 hours at 60 °C (140 °F) and 4 hours at 50 °C (122 °F) with humidity and condensation. The increase in stress at break is from the control samples. For more information see the [Impact of UV Exposure on FDM Materials](#) white paper.

Table 6: UV Aging of Antero 800NA - F900 - T20F Tip

Material	Conditioning	Yield Strength		Stress at Break		Elongation at Break	Increase in Stress at Break	Modulus	
		(psi)	(MPa)	(psi)	(MPa)			(ksi)	(GPa)
Antero 800NA	No UV Exposure	8320	57.4	8360	57.6	2.4	-	392	2.7
	UV Exposure	8310	57.3	8670	59.7	2.4	3.60	399	2.75

Performance at Temperature

Antero 800NA coupons were built on the F900 using the T20F tip with 0.254 mm (0.010 in.) layer height. Antero 800NA was tested at various temperatures. Ten ASTM D638 upright (ZX) coupons were tested in tensile. The percent change from the reported room temperature results are listed below. For more information see the [Impact of Temperature on High-Performance FDM Materials](#) white paper.

Table 7: Performance of Antero 800NA at Temperatures - F900 - T20F Tip

Material	Temperature		Strength at Break	Elongation at Break	Modulus
	(°F)	(°C)			
Antero 800NA	-65	-54	113%	100%	124%
	-40	-40	118%	109%	119%
	120	49	110%	122%	108%
	180	82	103%	139%	110%
	220	104	82%	148%	104%
	270	132	63%	148%	101%



Chemical Resistance

Antero 800NA coupons were built on the Fortus 450mc using the T20D tip with 0.254 mm (0.010 in.) layer height. Antero 800NA was tested for resistance to chemical exposure per ASTM D543. Chemicals tested and percent change from control is listed below. For further details read the [Antero 800NA Chemical Resistance White Paper](#).

Table 8: Antero 800NA Chemical Resistance Results

Change in Tensile Properties – 168 Hour Chemical Exposure (ASTM D543)					
	Reagent	Non-Annealed XZ	Non-Annealed ZX	Annealed XZ	Annealed ZX
Tensile Strength	Dichloromethane	-88%	-81%	-15%	1%
	Ethyl Acetate	-20%	-4%	-19%	-7%
	Jet A	-14%	-3%	11%	-1%
	Methyl Ethyl Ketone	-17%	-7%	-16%	-7%
	Skydrol	-5%	16%	19%	-9%
	Toluene	-17%	-11%	-14%	-9%
	30% Nitric Acid	-8%	6%	-7%	7%
	30% Sulfuric Acid	2%	0%	-4%	1%
	60% NaOH	2%	-5%	7%	1%
	Concentrated Ammonia	2%	-4%	2%	4%
% Elongation @ Break	Dichloromethane	1135%	2264%	-11%	0%
	Ethyl Acetate	9%	-1%	3%	-5%
	Jet A	25%	-1%	45%	2%
	Methyl Ethyl Ketone	21%	-2%	16%	-2%
	Skydrol	24%	26%	48%	-7%
	Toluene	8%	-7%	12%	-7%
	30% Nitric Acid	-10%	8%	-12%	7%
	30% Sulfuric Acid	4%	-3%	-4%	4%
	60% NaOH	9%	-10%	8%	3%
	Concentrated Ammonia	10%	-9%	12%	11%
Tensile Modulus	Dichloromethane	-92%	-93%	-1%	-1%
	Ethyl Acetate	-3%	-4%	-3%	-1%
	Jet A	-3%	-3%	-4%	-3%
	Methyl Ethyl Ketone	-2%	-6%	-4%	-4%
	Skydrol	-3%	-4%	-1%	-4%
	Toluene	-1%	-4%	-3%	-3%
	30% Nitric Acid	0%	-6%	-2%	2%
	30% Sulfuric Acid	2%	0%	2%	-2%
	60% NaOH	-1%	7%	3%	0%
	Concentrated Ammonia	-1%	10%	0%	-8%



Flame, Smoke, and Toxicity

Antero 800NA was printed with a T20D tip on the Stratasys F900 and tested per 14 CFR 25.853, BSS 7238 and 7239, and AITM 2.0007B and 3.0005. The testing establishes that this material meets requirements for:

- 60s and 12s Vertical Burn
- 15s Horizontal Burn
- Toxic Gas Emission
- Heat Release Rate of Cabin Materials
- Smoke Density

Table 9: Antero 800NA Flame, Smoke, and Toxicity Test Results

	Avg Time to Extinguish (seconds)	Avg Burned Length (inches)	Avg Burned Length (centimeters)	Drip Time to Extinguish (seconds)			
12 Second Vertical Ignition per 14 CFR 25.853(a), Appendix F, Part I, Paragraph (a)(1)(ii)							
Antero 800NA - Flat Build XY	<1	1.23	3.12	0 (no drips)			
Antero 800NA - Vertical - ZX	<1	1.11	2.82	0 (no drips)			
60 Second Vertical Ignition per 14 CFR 25.853(a), Appendix F, Part I, Paragraph (a)(1)(i)							
Antero 800NA - Flat Build XY	1.1	2.45	6.22	0 (no drips)			
Antero 800NA - Vertical - ZX	1.1	2.86	7.26	0 (no drips)			
	Avg Time to Extinguish (seconds)	Avg Burned Length (inches)	Avg Burned Length (centimeters)	Burn Rate (inches/minute)			
Antero 800NA - Flat Build XY	0	0	0	0			
Antero 800NA - Vertical - ZX	0	0	0	0			
Test Mode	Average Ds (maximum) within 4 minutes, (4Dmax)						
Smoke Density per BSS 7238, Rev. C							
Antero 800NA - Flat Build XY	Flaming			2			
Antero 800NA - Vertical - ZX	Flaming			2			
Smoke Density per AITM 2.0007B, Issue 3							
Antero 800NA - Flat Build XY	Flaming			1			
Antero 800NA - Vertical - ZX	Flaming			2			
Antero 800NA - Flat Build XY	Non-flaming			1			
Antero 800NA - Vertical - ZX	Non-flaming			1			
Test Mode	CO ppm	SO ₂ ppm	NO _x ppm	HCN ppm	HCl ppm	HF ppm	
Toxic Gas Emission per BSS 7239, Rev. A							
Antero 800NA - Flat Build XY	0	1.3	0.5	1	0.2	64	
Antero 800NA - Vertical - ZX	0	1.4	0.5	0	0.2	86	
Toxic Gas Emission per AITM 3.0005, Issue 2							
Antero 800NA - Flat Build XY	Flaming	60	0	0.9	0.4	0	0
Antero 800NA - Vertical - ZX	Non-flaming	1	0	0	0	0	0
Antero 800NA - Flat Build XY	Flaming	50	0	1.3	0	0	0
Antero 800NA - Vertical - ZX	Non-flaming	1	0	0	0	0	0
	Peak HRR (kW/m ²)	Time to Peak Heat Release (seconds)	2 Minute Total HRR (kW-min/m ²)				
Heat Release Rate of Cabin Materials per 14 CFR 25.853(d), Appendix F, Part IV							
Antero 800NA - Flat Build XY	48.4	150	15.5				
Antero 800NA - Vertical - ZX	49.4	92	38.6				



Outgassing

Table 10: Antero 800NA Outgassing (ASTM E595) - T20D Tip

Sample	TML (%)	CVCM (%)	WVR (%)
Antero 800NA	0.347	0.004	0.267

Fire Protection of Railway Vehicles

Antero 800NA was printed with a T20F tip on the Stratasys F900, using single contour and +45/-45 solid rasters, which are typical default settings and tested per EN 45545-2.

Table 11: Antero 800NA Resin Fire Protection of Railway Vehicles Test Results for R1 Requirement Set

Test	Results	5 mm XZ	25 mm XZ
ISO 5659-2	Ds(4)	-	16.19
ISO 5659-2	VOF ₄	-	19.87
ISO 5659-2 + EN 45545-2 Appendix C	ITC 4 minutes	-	0.00
ISO 5659-2 + EN 45545-2 Appendix C	ITC 8 minutes	-	0.034
ISO 5660-1	MAHRE (kW/m ²)	-	10.5
ISO 5658-2	CFE (kW/m ²)	12.5	-



Appendix

Figure 1: 2nd Heating Scan, DSC, for Antero 800NA

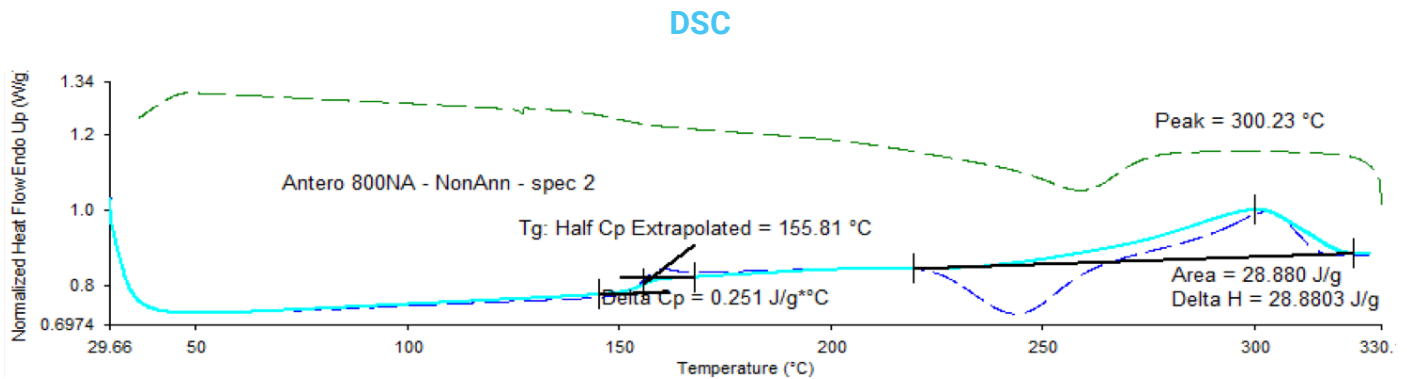

Figure 2: CTE for Antero 800NA Through the Layers

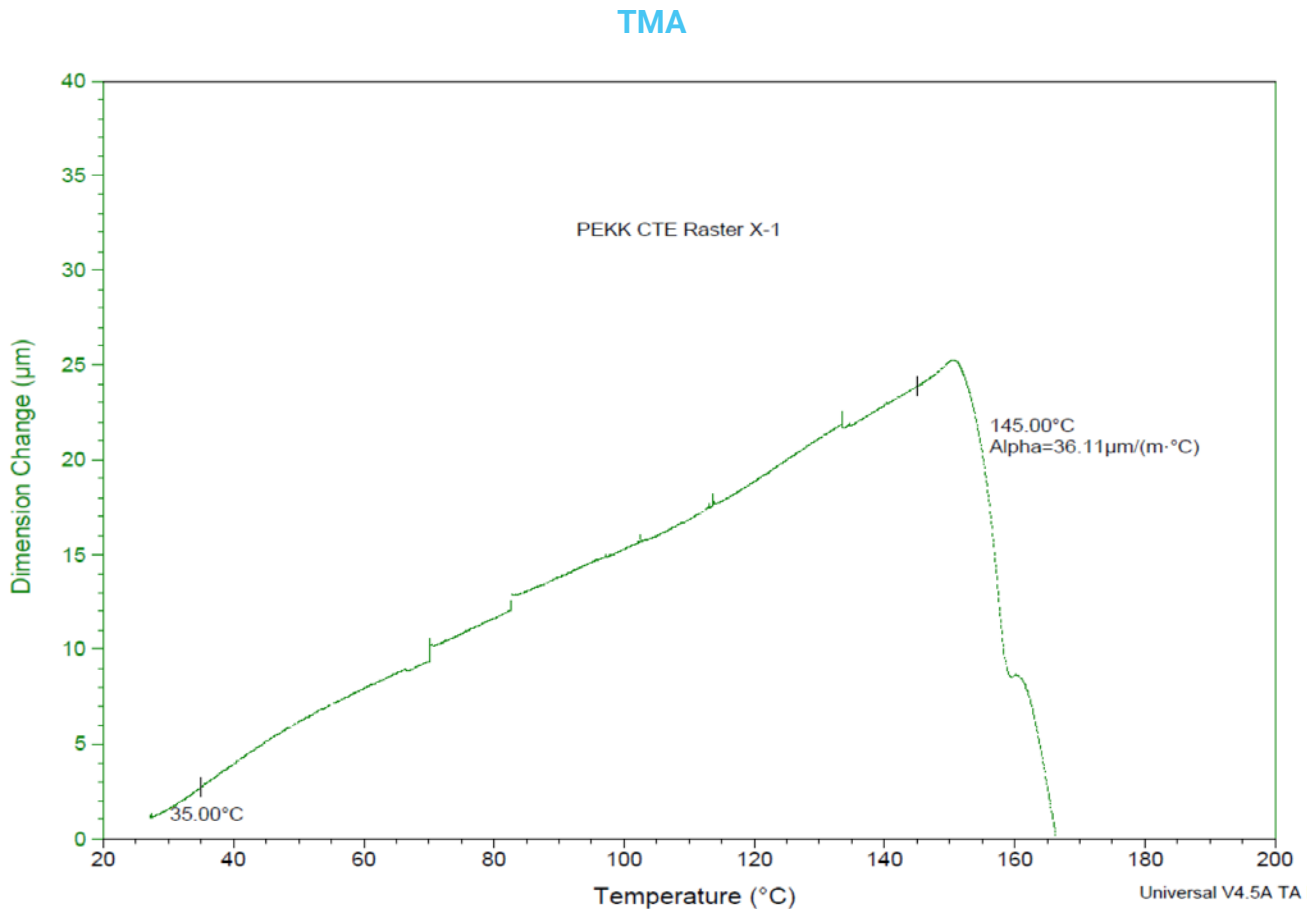
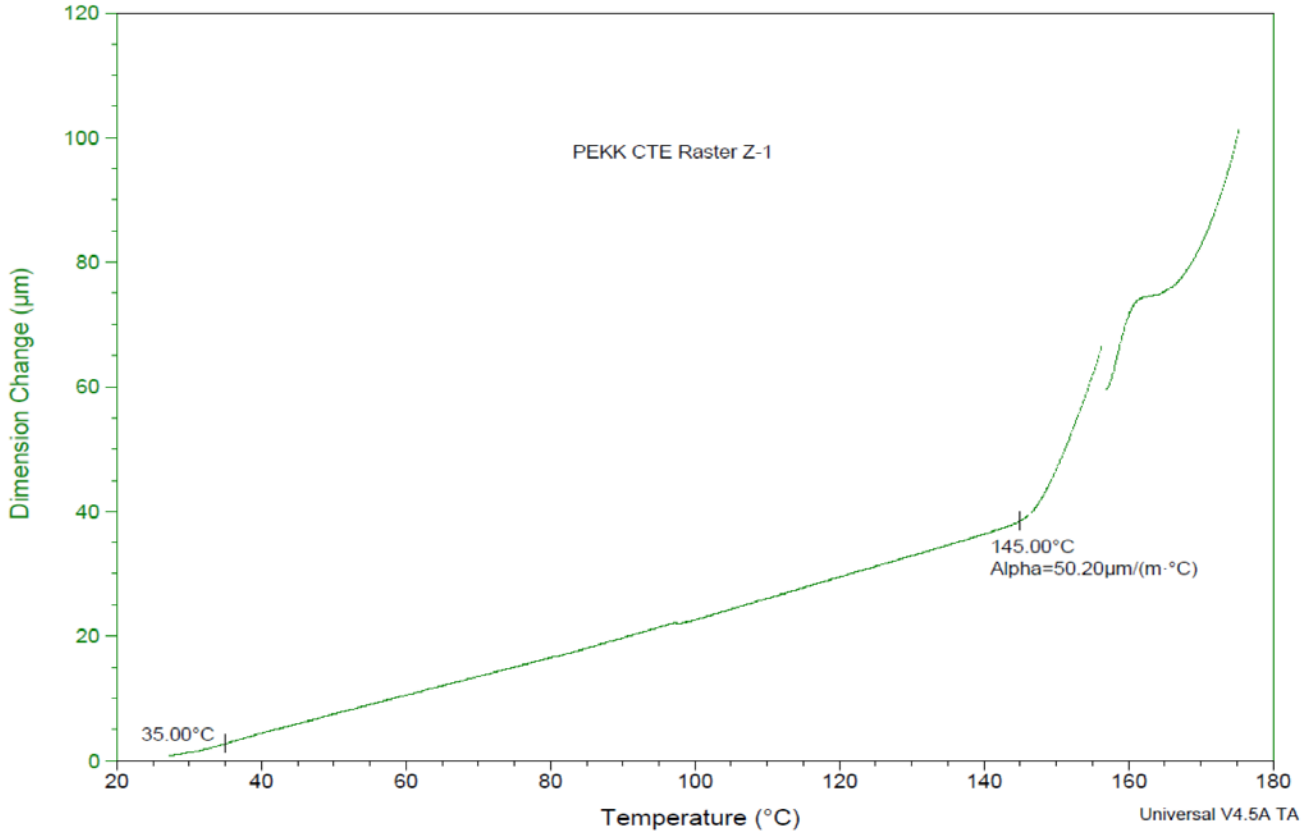



Figure 3: CTE for Antero 800NA in Plane to the Layers

TMA



stratasys.com
 ISO 9001:2015
 Certified

Stratasys Headquarters
 7665 Commerce Way,
 Eden Prairie, MN 55344
 +1 800 801 6491 (US Toll Free)
 +1 952 937-3000 (Intl)
 +1 952 937-0070 (Fax)

1 Holtzman St., Science Park,
 PO Box 2496
 Rehovot 76124, Israel
 +972 74 745 4000
 +972 74 745 5000 (Fax)

MATERIAL DATA SHEET
FDM

© 2024 Stratasys. All rights reserved. Stratasys, the Stratasys Signet logo, FDM, Fortus, Antero, and F900 are registered trademarks of Stratasys Inc. Fortus 450mc, and SUP8000B are trademarks of Stratasys, Inc. All other trademarks are the property of their respective owners, and Stratasys assumes no responsibility with regard to the selection, performance, or use of these non-Stratasys products. Product specifications subject to change without notice. MDS_FDM_Antero 800NA_0824a

Antero 840CN03

FDM Thermoplastic Filament

The information presented are typical values intended for reference and comparison purposes only. They should not be used for design specifications or quality control purposes.





Overview

Antero™ 840CN03 is a PEKK-based FDM thermoplastic combining the excellent physical and mechanical qualities of PEKK with electrostatic dissipative (ESD) properties. The material is filled 3% by weight with carbon nanotubes.

As a high-performance polymer, Antero 840CN03 exhibits exceptional chemical and wear resistance, ultra-low outgassing properties and consistent ESD performance. ESD values range from $10^4 - 10^9$ ohms per square inch. This makes the material particularly suitable for space and industrial applications where these qualities are critical.

Contents:

Overview	2
Ordering Information	3
Physical Properties.....	4
Mechanical Properties.....	5
Performance at Temperature	8
UV Aging	8
ESD Properties	9
Chemical Resistance	11
Flame, Smoke, and Toxicity.....	14
Outgassing	15
Appendix.....	16



Ordering Information

Table 1: Printer and Support Material Compatibility

Printer	Model Tip	Layer Height	Support Material	Support Tip
Fortus 450mc™	T20F	0.254 mm (0.010 in.)	SUP8000B™ (breakaway)	T16
F900®	T20D	0.254 mm (0.010 in.)	SUP8000B (breakaway)	T16
F900®	T20F	0.254 mm (0.010 in.)	SUP8000B (breakaway)	T16

Build Sheet

High Temperature

- 0.51 x 406 x 470 mm (0.02 x 16 x 18.5 in.)
- 0.51 x 660 x 965 mm (0.02 x 26 x 38 in.)

System Requirements

Fortus 450mc

- Hardened machine upgrade
- Hardened Fortus 450mc head
- Antero 840CN03 material license (included if new system)

F900

- Hardened F900 head
- Antero 840CN03 material license

Table 2: Antero 840CN03 Ordering Information

Part Number	Description
Filament Canisters	
355-02510	Antero 840CN03, 92.3 cu in. – Plus
355-03260	SUP8000B, 92.3 cu in. – Plus
Printer Consumables	
511-10730-S	T20D tip
511-10740-S	T20F tip
511-10401	T16 tip
325-00275-S	High Temperature build sheet, 0.02 x 16 x 18.5 in. (0.51 x 406 x 470 mm)
325-00475-S	High Temperature build sheet, 0.02 x 26 x 38 in. (0.51 x 660 x 965 mm)
Print Heads	
821726-XXXX	Hardened Fortus 450mc head (blue handle)
325-63500	Hardened F900 head (folded sheet metal handle)



Physical Properties

Values are measured as printed. XY, XZ, and ZX orientations were tested. For full details refer to the [Stratasys Materials Test Procedure](#). DSC and TMA curves can be found in the Appendix.

Table 3: Antero 840CN03 Physical Properties

Property	Test Method	XY	XZ/ZX
HDT @ 66 psi	ASTM D648 Method B	157.7 °C (315.8 °F)	158.4 °C (317.1 °F)
HDT @ 264 psi	ASTM D648 Method B	158.0 °C (316.3 °F)	157.0 °C (314.6 °F)
Molded HDT @ 66 psi	ASTM D648 Method B	149.5 °C (301.1 °F)	
Molded HDT @ 264 psi	ASTM D648 Method B	150.8 °C (303.4 °F)	
Tg	ASTM D7426 Inflection Point	157.6 °C (315.7 °F)	
Melt Point	ASTM D7426 Peak Heat	300.3 °C (572.5 °F)	
Mean CTE	ASTM E831 (40 °C to 140 °C)	47.4 μm/[m*°C] 26.33 μin/[in*°F]	51.24 μm/[m*°C] 28.47 μm/[m*°F]
Volume Resistivity ¹	ASTM D257	10 ⁴ -10 ⁹ * Ω*cm	
Thermal Conductivity	ASTM E1952 @0 °C	0.2369 W/m*K 0.1369 BTU/(hr*ft°F)	
Thermal Conductivity	ASTM E1952 @30 °C	0.2447 W/m*K 0.1414 BTU/(hr*ft°F)	
Thermal Conductivity	ASTM E1952 @60 °C	0.2530 W/m*K 0.1462 BTU/(hr*ft°F)	
Thermal Conductivity	ASTM E1952 @90 °C	0.2567 W/m*K 0.1483 BTU/(hr*ft°F)	
Thermal Diffusivity	ASTM E1952 @0 °C	0.162 mm ² /s 2.51*10 ⁻⁴ in ² /s	
Thermal Diffusivity	ASTM E1952 @30 °C	0.150 mm ² /s 2.33*10 ⁻⁴ in ² /s	
Thermal Diffusivity	ASTM E1952 @60 °C	0.142 mm ² /s 2.20*10 ⁻⁴ in ² /s	
Thermal Diffusivity	ASTM E1952 @90 °C	0.134 mm ² /s 2.08*10 ⁻⁴ in ² /s	
Specific Gravity	ASTM D792 @23 °C	1.27	

¹See ESD section.



Mechanical Properties

Samples were printed with 0.254 mm (0.010 in.) layer heights on the Fortus 450mc and F900 with a T20F tip. For the full test procedure please see [Stratasys Materials Test Procedure](#).

Print Orientation

Parts created using FDM are anisotropic as a result of the printing process. Below is a reference of the different orientations used to characterize the material.

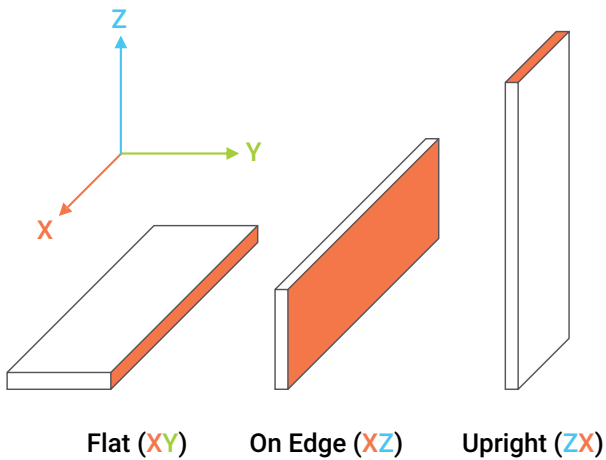

Tensile Curves

Due to the anisotropic nature of FDM, tensile curves look different depending on orientation. Below is a guide of the two types of curves seen when printing tensile samples and what reported values mean.

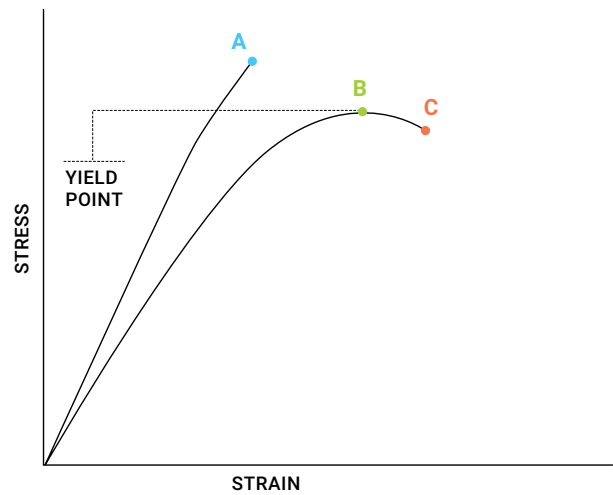

A = Tensile at break, elongation at break (no yield point)

B = Tensile at yield, elongation at yield

C = Tensile at break, elongation at break

Table 4: Antero 840CN03 Mechanical Properties - 450mc - T20F Tip

0.254 mm (0.010 in.) Layer Height		XZ Orientation ¹	ZX Orientation ¹
Tensile Properties: ASTM D638			
Yield Strength	MPa	94.9 (1.0)	56.0 (5.0)
	psi	13800 (140)	8110 (720)
Elongation @ Yield	%	4.9	2.0
Strength @ Break	MPa	No Break	55.8 (4.9)
	psi	No Break	8090 (710)
Elongation @ Break	%	No Break	2.0
Modulus (Elastic)	GPa	2.96 (0.03)	3.02 (0.046)
	ksi	430 (4.9)	438 (6.7)
Flexural Properties: ASTM D790, Procedure A			
Strength @ Break	MPa	No Break	89.0 (9.4)
	psi	No Break	12900 (1400)
Strength @ 5% Strain	MPa	146 (1.7)	-
	psi	21100 (240)	-
Strain @ Break	%	No Break	3.2
Modulus	GPa	3.44 (0.04)	2.89 (0.08)
	ksi	499 (6.0)	419 (11)
Compression Properties: ASTM D695			
Yield Strength	MPa	106 (1.7)	109 (3.0)
	psi	15400 (240)	15700 (430)
Modulus	GPa	2.55 (0.04)	2.52 (0.05)
	ksi	369 (5.4)	365 (6.8)
Impact Properties: ASTM D256, ASTM D4812			
Notched	J/m	45.0 (6.0)	29.7 (5.9)
	ft*lb/in.	0.842 (0.11)	0.556 (0.11)
Unnotched	J/m	4060 (1600)	124 (30)
	ft*lb/in.	76.0 (29)	2.32 (0.56)

¹Values in parentheses are standard deviations.

Table 5: Antero 840CN03 Mechanical Properties - F900 - T20F Tip

0.254 mm (0.010 in.) Layer Height		XZ Orientation ¹	ZX Orientation ¹
Tensile Properties: ASTM D638			
Yield Strength	MPa	93.9 (2.15)	53.1 (4.1)
	psi	13600 (310)	7690 (600)
Elongation @ Yield	%	4.8	1.9
Strength @ Break	MPa	54.1 (11)	52.6 (4.0)
	psi	7850 (1500)	7630 (580)
Elongation @ Break	%	12	1.9
Modulus (Elastic)	GPa	2.94 (0.05)	2.88 (0.07)
	ksi	426 (7.5)	418 (11)
Flexural Properties: ASTM D790, Procedure A			
Strength @ Break	MPa	No Break	85.3 (14)
	psi	No Break	12400 (2100)
Strength @ 5% Strain	MPa	144 (4.6)	-
	psi	20800 (670)	-
Strain @ Break	%	No Break	3.1
Modulus	GPa	3.43 (0.09)	2.80 (0.06)
	ksi	498 (13)	405 (9.2)
Compression Properties: ASTM D695			
Yield Strength	MPa	106 (3.3)	106 (3.1)
	psi	15400 (480)	15400 (440)
Modulus	GPa	2.60 (0.04)	2.56 (0.03)
	ksi	377 (6.0)	371 (4.5)
Impact Properties: ASTM D256, ASTM D4812			
Notched	J/m	45.8 (5.9)	30.7 (4.4)
	ft*lb/in.	0.858 (0.11)	0.575 (0.08)
Unnotched	J/m	1930 (950)	143.2 (32)
	ft*lb/in.	36.2 (18)	2.68 (0.61)

¹ Values in parentheses are standard deviations.



Performance at Temperature

Antero 840CN03 was tested at various temperatures. Ten ASTM D638 upright (ZX) T20F dogbone coupons were tested in tensile. The percent change from the reported room temperature results are listed below. For more information, see the [FDM Strength Performance Across Temperatures white paper](#).

Table 6. Performance of Antero 840CN03 at Temperature - T20F Tip

Material	Temperature		Strength at Break	Elongation at Break	Modulus
	(°F)	(°C)			
Antero 840CN03	-65	-54	98%	89%	120%
	-40	-40	99%	89%	119%
	120	49	94%	100%	105%
	180	82	98%	111%	103%
	220	104	96%	126%	102%
	270	132	76%	132%	101%

UV Aging

Antero 840CN03 was tested before and after UV exposure. Ten ASTM D638 upright (ZX) dogbones were tested in tensile after UV exposure and an additional 10 ASTM D638 ZX dogbones were the control (no UV Exposure). The UV exposed samples were cycled in the QUV chamber per ASTM G154 (Standard Practice for Operating Fluorescent Ultraviolet (UV) Lamp Apparatus for exposure of Non-metallic Materials) for 1000 hours, alternating for 8 hours at 60 °C (140 °F) and 4 hours at 50 °C (122 °F) with humidity and condensation. The increase in stress at break is from the control samples.

For more information see the Impact of [UV Exposure on FDM Materials white paper](#).

Table 7: UV Aging of Antero 840CN03 - F900 - T20F Tip

Material	Conditioning	Yield Strength		Stress at Break		Elongation at Break	Increase in Stress at Break	Modulus	
		(psi)	(MPa)	(psi)	(MPa)			(ksi)	(GPa)
Antero 840CN03	No UV Exposure	8270	57	8400	57.9	2.4	-	396	2.73
	UV Exposure	8050	55.5	8040	55.4	2.2	-4.30	401	2.76



ESD Properties

Antero 840CN03 was tested per ANSI ESD S20.20, S11.11, STM11.12 to determine the effect that build parameters and part geometries had on ESD properties. Different geometries printed in different orientations all fall into the ESD safe range (10^4 to 10^9 ohms). For full details, see the [Antero 840CN03 ESD White Paper](#).

Figure 1a: 4 x 4 x 0.1 in. Plaque Resistance on the Fortus 450mc in Various Build Orientations

Fortus 450mc

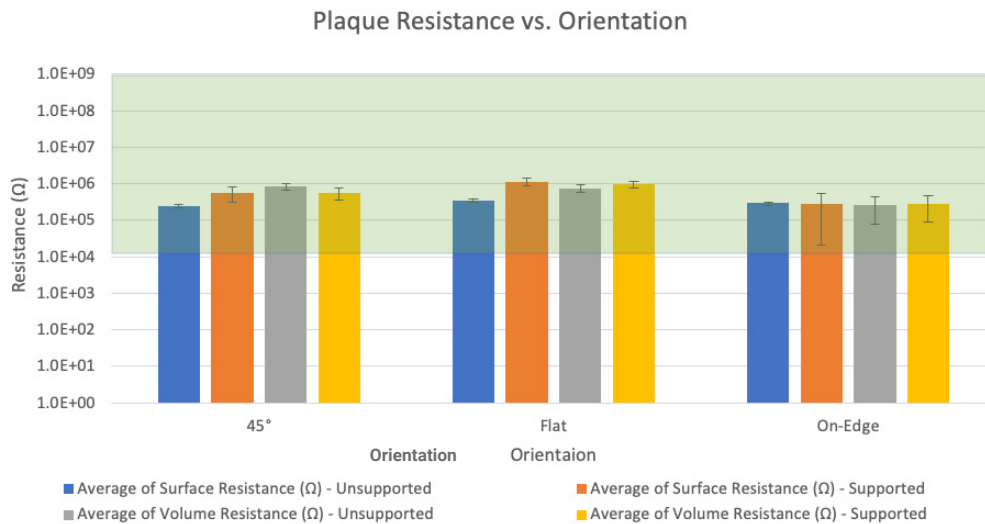

Figure 1b: 4 x 4 x 0.1 in. Plaque Resistance on the F900 in Various Build Orientations

F900

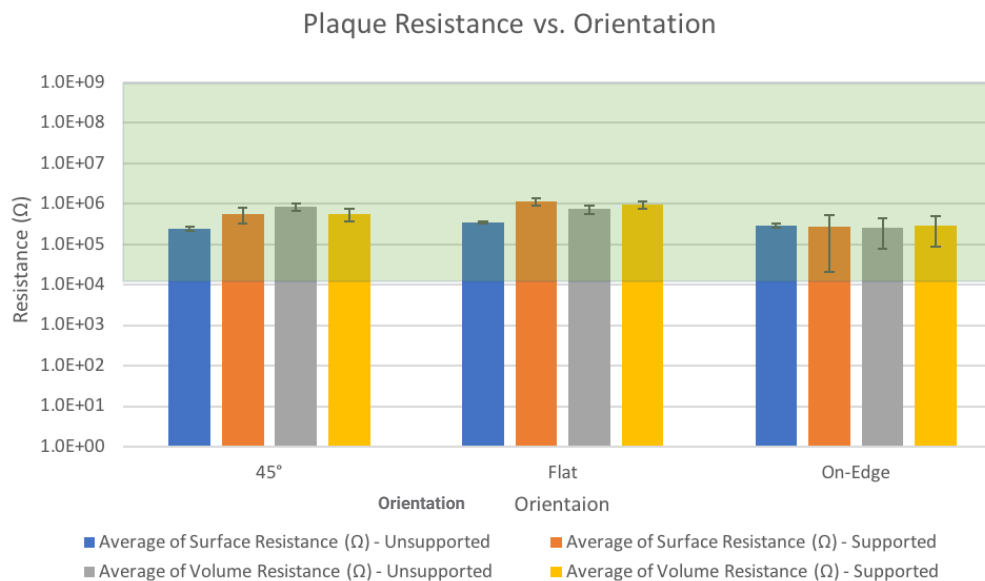



Figure 2a: Volume Resistance of Hollow Cylinders With Respect to Wall Thickness, Build Orientation, and Location on the Cylinder on the Fortus 450mc

Fortus 450mc

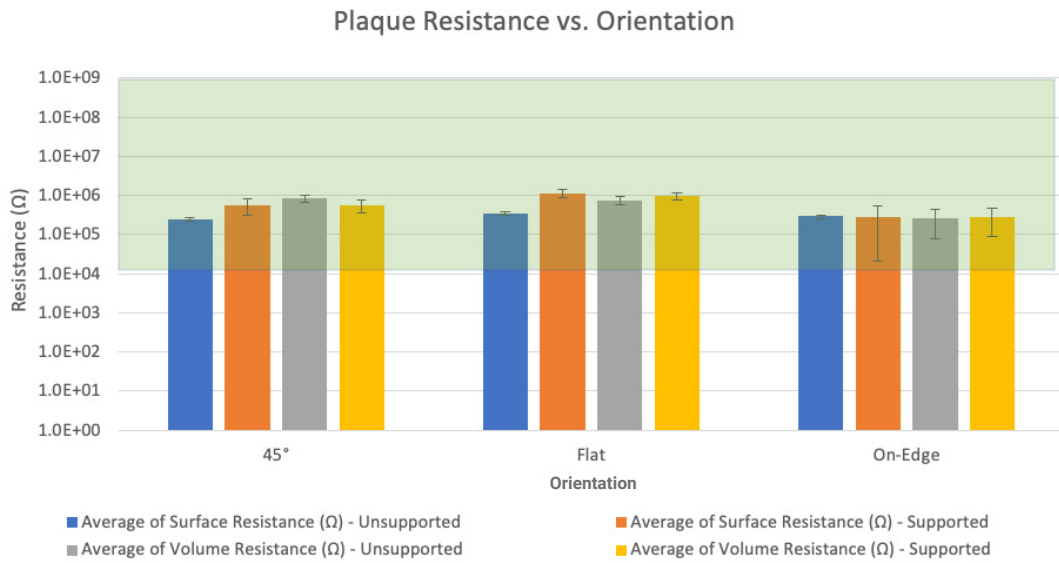
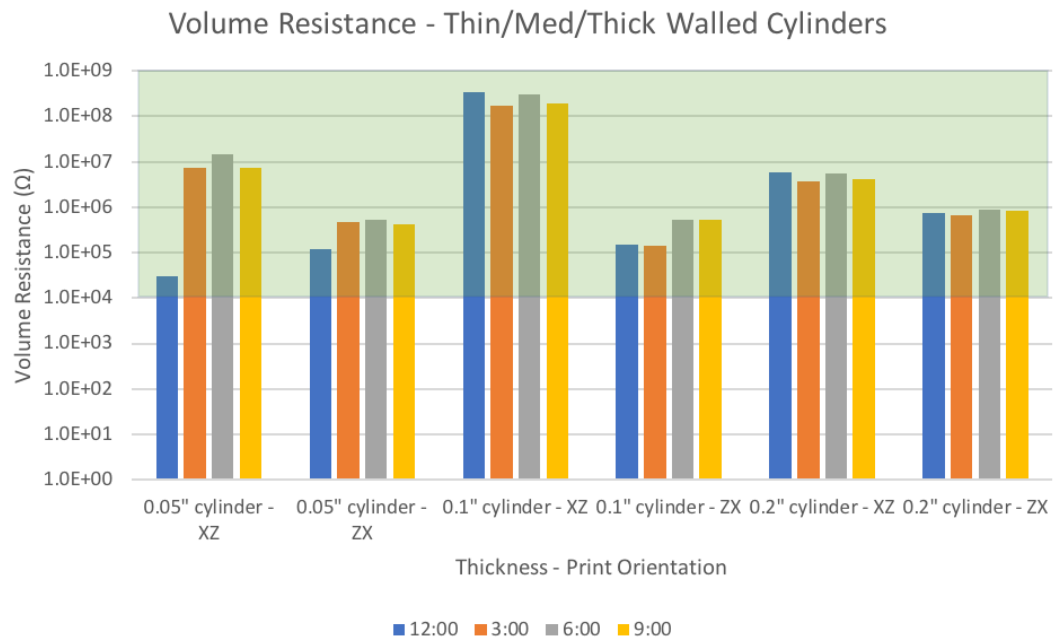

Figure 2b: Volume Resistance of Hollow Cylinders With Respect to Wall Thickness, Build Orientation, and Location on the Cylinder on the F900

F900





Chemical Resistance

Antero 840CN03 was tested for resistance to chemical exposure per ASTM D543. Chemicals tested and percent change from control is listed below. For further details read the [Antero 840CN03 Chemical Resistance White Paper](#).

Table 8: Antero 840CN03 Thermoplastic Filament Chemical Resistance Results

Change in Mechanical Properties, Antero 840CN03 - 168 Hour Chemical Exposure (ASTM D543)			
	Reagent	XZ Orientation	ZX Orientation
Tensile Strength	Dichloromethane	-87.6%	-74.8%
	Ethyl Acetate	-2.9%	-2.3%
	Jet A	-2.1%	7.3%
	MEK	-0.7%	-2.1%
	Skydrol	-2.1%	6.3%
	Toluene	-5.0%	1.4%
	30% Nitric Acid	-5.7%	5.7%
	30% Sulfuric Acid	-9.3%	-10.1%
	60% Sodium Hydroxide	-1.4%	1.9%
	Concentrated Ammonia	-1.4%	11.0%
% Elongation @ break	Dichloromethane	714.8%	1,598.4%
	Ethyl Acetate	4.2%	16.2%
	Jet A	-0.4%	7.0%
	MEK	-4.4%	11.9%
	Skydrol	32.3%	9.7%
	Toluene	17.2%	32.4%
	30% Nitric Acid	61.4%	52.4%
	30% Sulfuric Acid	47.2%	-5.4%
	60% Sodium Hydroxide	5.2%	-1.6%
	Concentrated Ammonia	11.1%	10.8%
Tensile Modulus	Dichloromethane	-90.7%	-85.3%
	Ethyl Acetate	1.8%	6.4%
	Jet A	1.4%	5.3%
	MEK	3.1%	4.3%
	Skydrol	0.6%	6.7%
	Toluene	-0.4%	6.2%
	30% Nitric Acid	-0.8%	-6.2%
	30% Sulfuric Acid	-7.6%	-5.0%
	60% Sodium Hydroxide	0.2%	3.3%
	Concentrated Ammonia	-0.4%	5.0%



Flame, Smoke, and Toxicity (Fortus 450mc)

Antero 840CN03 was printed with a T20F tip on the Stratasys Fortus 450mc and tested per 14 CFR 25.853, BSS 7238 and 7239, and AITM 2.0007B, and 3.0005. The testing establishes that this material, samples 1.016 mm (0.040 in.) thick unless otherwise noted, **meets requirements** for:

- 60s and 12s Vertical Burn
- 15s Horizontal Burn
- Toxic Gas Emission
- Smoke Density
- Heat Release Rate of Cabin Materials

Table 9: Antero 840CN03 Flame, Smoke and Toxicity Test Results - Fortus 450mc

	Avg Time to Extinguish (seconds)	Avg Burned Length (inches)	Avg Burned Length (centimeters)	Drip Time to Extinguish (seconds)
12 Second Vertical Ignition per 14 CFR 25.853(a), Appendix F, Part I, Paragraph (a)(1)(ii)				
Antero 840CN03, Vertical - ZX	2.9	0.2	0.5	0 (No drips)
Antero 840CN03, Flat - XY	6.7	0.2	0.5	0 (No drips)
60 Second Vertical Ignition per 14 CFR 25.853(a), Appendix F, Part I, Paragraph (a)(1)(ii)				
Antero 840CN03, Vertical - ZX	<1	0.4	1.02	0 (No drips)
Antero 840CN03, Flat - XY	<1	0.5	1.27	0 (No drips)
	(in/min)	Avg Burn Rate		(cm/min)
15 Second Vertical Ignition per 14 CFR 25.853(a), Appendix F, Part I, Paragraph (a)(1)(ii)				
Antero 840CN03, Vertical - ZX	0			0
Antero 840CN03, Flat - XY	0			0
	Test Mode	Average D_s (maximum) within 4 minutes, ($^4D_{max}$)		
Smoke Density per BSS 7238, Rev C				
Antero 840CN03, Vertical - ZX	Flaming	0		
Antero 840CN03, Flat - XY	Flaming	0		
Smoke Density per AITM 2.0007B, Issue 3				
Antero 840CN03, Vertical - ZX	Flaming	0		
Antero 840CN03, Flat - XY	Flaming	0		
Antero 840CN03, Vertical - ZX	Non-Flaming	0		
Antero 840CN03, Flat - XY	Non-Flaming	0		



Table 10: Antero 840CN03 Flame, Smoke and Toxicity Test Results - Fortus 450mc

	Test Mode	CO ppm	SO ₂ ppm	NO _x ppm	HCN ppm	HCl ppm	HF ppm
Toxic Gas Emission per BSS 7239, Rev. A							
Antero 840CN03, Vertical - ZX	Flaming	5	0 (NI)	0 (NI)	0 (NI)	0 (NI)	0 (NI)
Antero 840CN03, Horizontal - XY	Flaming	<5	0 (NI)	0 (NI)	0 (NI)	0 (NI)	0 (NI)
Toxic Gas Emission per AITM 3.0005, Issue 2							
Antero 840CN03, Vertical - ZX	Flaming	5	0	0.1	0 (NI)	0 (NI)	0 (NI)
Antero 840CN03, Horizontal - XY	Flaming	3	0	0.3	0 (NI)	0 (NI)	0 (NI)
Antero 840CN03, Vertical - ZX	Non-Flaming	1	0	0	0 (NI)	0 (NI)	0 (NI)
Antero 840CN03, Horizontal - XY	Non-Flaming	1	0	0	0 (NI)	0 (NI)	0 (NI)
	Peak HRR (kW/m ²)	Time to Peak Heat Release (seconds)		2 Minute Total HRR (kW-min/m ²)			
Heat Release Rate of Cabin Materials per 14 CFR 25.853(d), Appendix F, Part IV¹							
Antero 840CN03, Vertical - ZX Antero 840CN03	57.7	300		0			
Antero 840CN03, Horizontal - XY	59.9	269		0.1			

¹ Sample thickness: 0.150 in.



Flame, Smoke, and Toxicity (F900)

Antero 840CN03 was printed with a T20D tip on the Stratasys F900 and tested per 14 CFR 25.853, BSS 7238 and 7239, and AITM 2.0007B and 3.0005. The testing establishes that this material, samples 1.016 mm (0.040 in.) thick unless otherwise noted, **meets requirements** for:

- 60s and 12s Vertical Burn
- 15s Horizontal Burn
- Toxic Gas Emission
- Smoke Density
- Heat Release Rate of Cabin Materials

Table 11: Antero 840CN03 Flame, Smoke, and Toxicity Test Results - F900

	Avg Time to Extinguish (seconds)	Avg Burned Length (inches)	Avg Burned Length (centimeters)	Drip Time to Extinguish (seconds)
12 Second Vertical Ignition per 14 CFR 25.853(a), Appendix F, Part I, Paragraph (a)(1)(ii)				
Antero 840CN03, Vertical - ZX	3.2	0.3	0.76	0 (no drips)
Antero 840CN03, Horizontal - XZ	4.7	0.2	0.51	0 (no drips)
60 Second Vertical Ignition per 14 CFR 25.853(a), Appendix F, Part I, Paragraph (a)(1)(i)				
Antero 840CN03, Vertical - ZX	<1	0.5	1.27	0 (no drips)
Antero 840CN03, Horizontal - XZ	<1	0.5	1.27	0 (no drips)
		Avg Burn Rate		
		(in/min)		(cm/min)
15 Second Horizontal Ignition per 14 CFR 25.853(a), Appendix F, Part I, Paragraph (a)(1)(iv)(v)				
Antero 840CN03, Vertical - ZX		0		0
Antero 840CN03, Horizontal - XZ		0		0
Test Mode		Average D_s (maximum) within 4 minutes, (${}^4D_{max}$)		
Smoke Density per BSS 7238, Rev. C				
Antero 840CN03, Vertical - ZX	Flaming	0		
Antero 840CN03, Horizontal - XZ	Flaming	0		
Smoke Density per AITM 2.0007B, Issue 3				
Antero 840CN03, Vertical - ZX	Flaming	0		
Antero 840CN03, Horizontal - XZ	Flaming	0		
Antero 840CN03, Vertical - ZX	Non-Flaming	0		
Antero 840CN03, Horizontal - XZ	Non-Flaming	0		

Table 12: Antero 840CN03 Flame, Smoke, and Toxicity Test Results - F900

	Test Mode	CO ppm	SO ₂ ppm	NO _x ppm	HCN ppm	HCl ppm	HF ppm
Toxic Gas Emission per BSS 7239, Rev. A							
Antero 840CN03, Vertical - ZX	Flaming	5	0	0	0	0	0
Antero 840CN03, Horizontal - XZ	Flaming	<5	0	0	0	0	0
Toxic Gas Emission per AITM 3.0005, Issue 2							
Antero 840CN03, Vertical - ZX	Flaming	4	0	0.1	0	0	0
Antero 840CN03, Horizontal - XZ	Flaming	3	0	0.3	0	0	0
Antero 840CN03, Vertical - ZX	Non-Flaming	0	0	0	0	0	0
Antero 840CN03, Horizontal - XZ	Non-Flaming	1	0	0	0	0	0
	Peak HRR (kW/m ²)	Time to Peak Heat Release (seconds)		2 Minute Total HRR (kW-min/m ²)			
Heat Release Rate of Cabin Materials per 14 CFR 25.853(d), Appendix F, Part IV¹							
Antero 840CN03, Horizontal - XZ	55.9	286.7		0			
Antero 840CN03, Vertical - ZX	55.1	293		0.1			

¹ Sample thickness: 0.150 in.

Outgassing

Table 13: Antero 840CN03 Outgassing Test Results

Sample	TML (%)	CVCM (%)	WVR (%)
Vertical Build - ZX	0.41	<0.01	0.17
Horizontal Build - XZ	0.45	0.01	0.15
Testing Observations²			
Visible Condensate	Yes	Opaque	Yes
Percent Covered	10% (ZX), 25% (XZ)	Interference Fringes	No
Thin	Yes	Colored Fringes	No
Heavy	No	Sample Appearance After Test	No change
Transparent	No		

²For both XZ and ZX orientations.



Appendix

Figure 3: 2nd Heating Scan, DSC, for Antero 840CN03

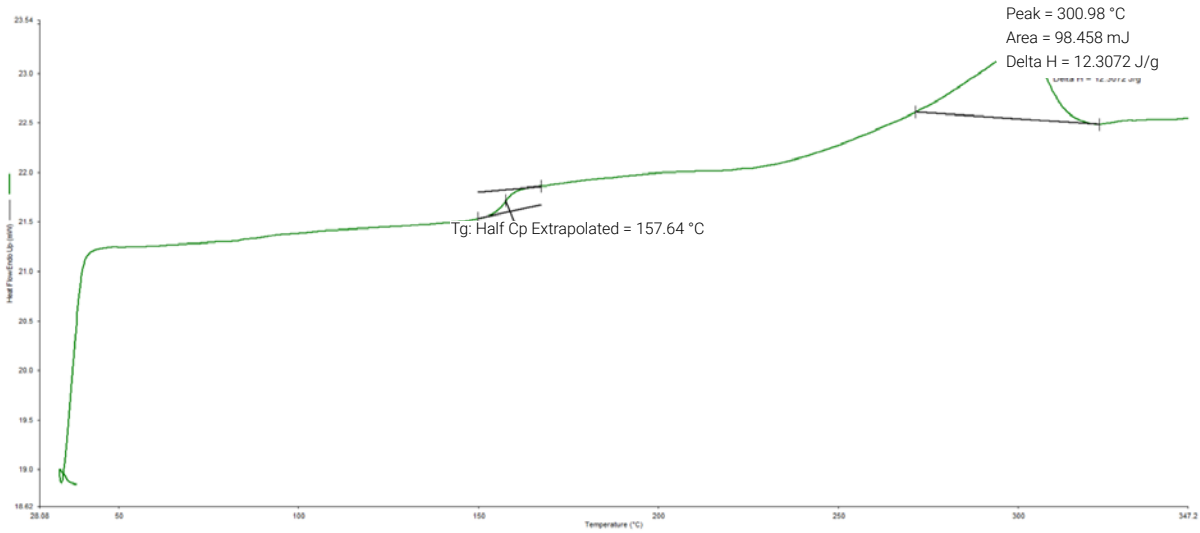

Figure 4: TMA CTE Curve Normal to the Layers

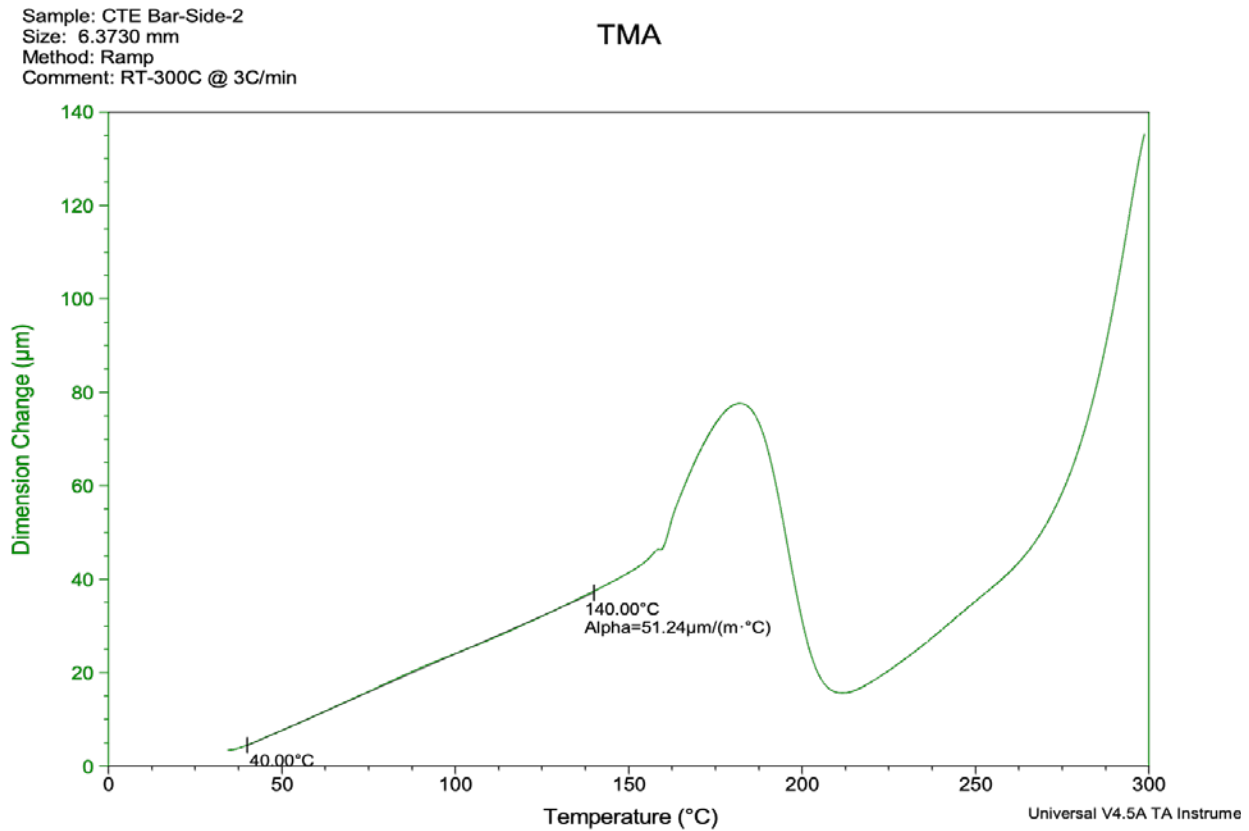
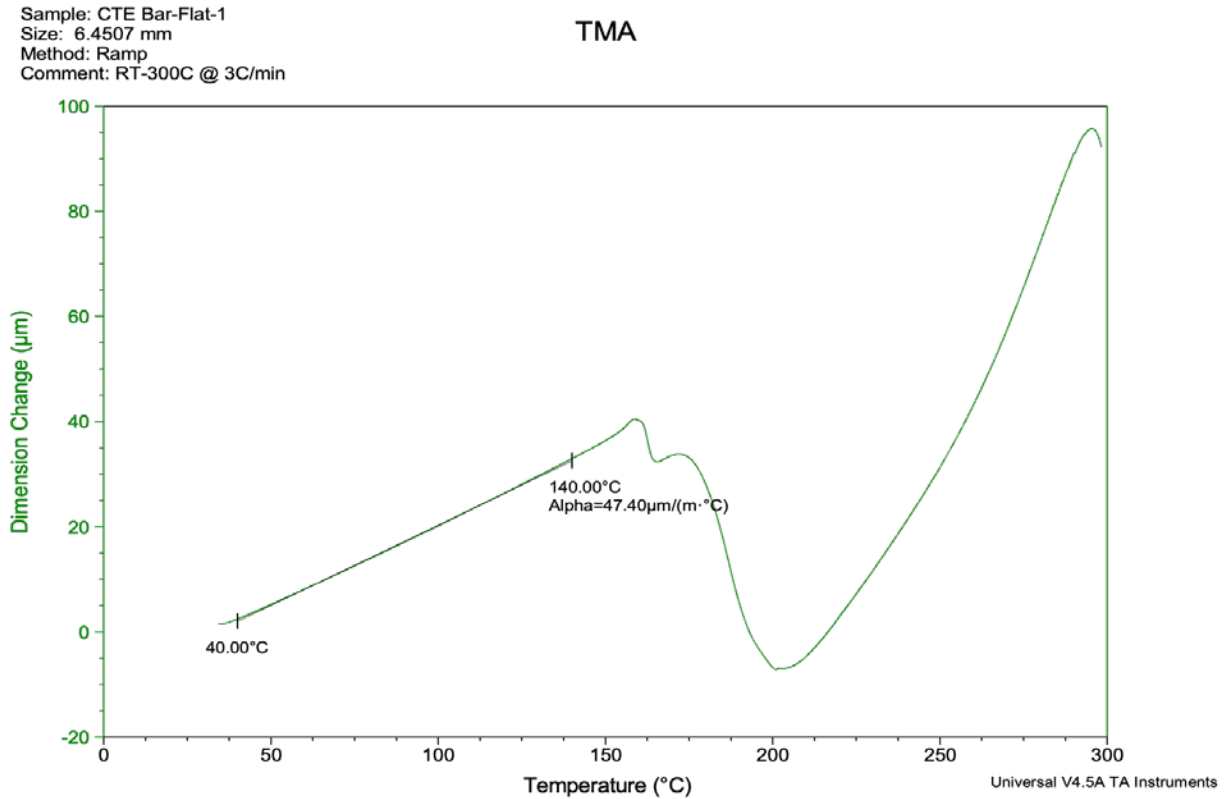



Figure 5: TMA CTE Curve Inplane with the Layers



[stratasys.com](https://www.stratasys.com)
ISO 9001:2015
Certified

Stratasys Headquarters
7665 Commerce Way,
Eden Prairie, MN 55344
+1 800 801 6491 (US Toll Free)
+1 952 937-3000 (Intl)
+1 952 937-0070 (Fax)

1 Holtzman St., Science Park,
PO Box 2496
Rehovot 76124, Israel
+972 74 745 4000
+972 74 745 5000 (Fax)

MATERIAL DATA SHEET
FDM

© 2024 Stratasys. All rights reserved. Stratasys, the Stratasys Signet logo, FDM, Fortus, Antero, and F900 are registered trademarks of Stratasys Inc., Fortus 450mc, and SUP8000B are trademarks of Stratasys, Inc. All other trademarks are the property of their respective owners, and Stratasys assumes no responsibility with regard to the selection, performance, or use of these non-Stratasys products. Product specifications subject to change without notice. MDS_FDM_Antero840CN03_0824a